

Railway Technology Today 12 (Edited by Kanji Wako)

Magnetic Levitation (Maglev) Technologies

1. Superconducting Maglev Developed by RTRI and JR Central

Kazuo Sawada

The Tokaido Shinkansen began operations in 1964 and was an immediate success. Since then, Japan's shinkansen network has expanded considerably, and its success has prompted rapid development of high-speed railways in other countries as well, especially in the West. In its early days, the shinkansen was

considered the ultimate form of high-speed rail travel. But passengers in Japan now demand even faster rail service, as we can see in the preference they have recently shown for the *Nozomi* on the San'yo Shinkansen that runs at 300 km/h, or 70 km/h faster than the older *Hikari*. The shinkansen uses a conventional train

design, with motors and other equipment mounted on the rolling stock, electric power collected from overhead wires, and wheels running on rails. It is extremely difficult to modify this conventional design to increase speeds much more. Some inherent limitations are:

- Greater size and weight of on-board equipment
- Difficulty in collecting electric power
- Reduced adhesion between wheels and rails at higher speeds, causing wheel slip

The shinkansen, and other similar high-

Figure 1 Different Propulsion Methods of Conventional Electric Railways and Superconducting Maglev Guideway

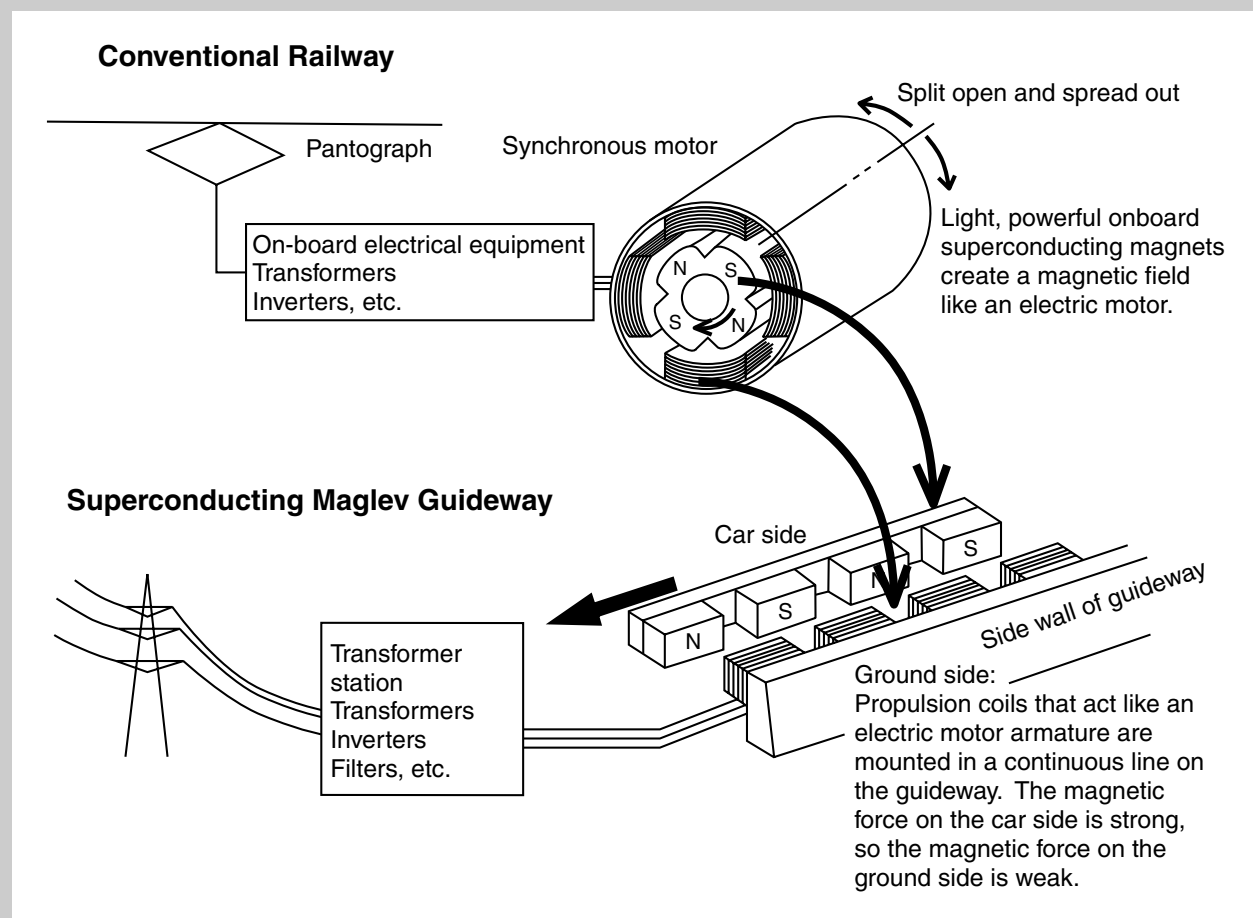

speed trains in different parts of the world, have made rail travel faster than ever before, but the speed is reaching the maximum possible with present technology.

To break through this speed barrier, the Railway Technical Research Institute (RTRI) and JR Central are working together to develop technologies for a new type of railway that is ideal for high speed travel—the superconducting magnetically levitated train (maglev).

Advantages of Superconducting Maglev

Superconducting maglevs are also called linear motor cars. The motor is linear, not rotary. We can think of it as an ordinary electric motor that has been split open, spread out flat, and oriented in the direction of train travel (Fig. 1). The motor does not rotate; instead, it exerts a kinetic force in a straight line, or guideway. One part of the linear motor is mounted on the train, the other on the guideway. The train has light but powerful superconducting magnets, and the guideway has energized coils along the

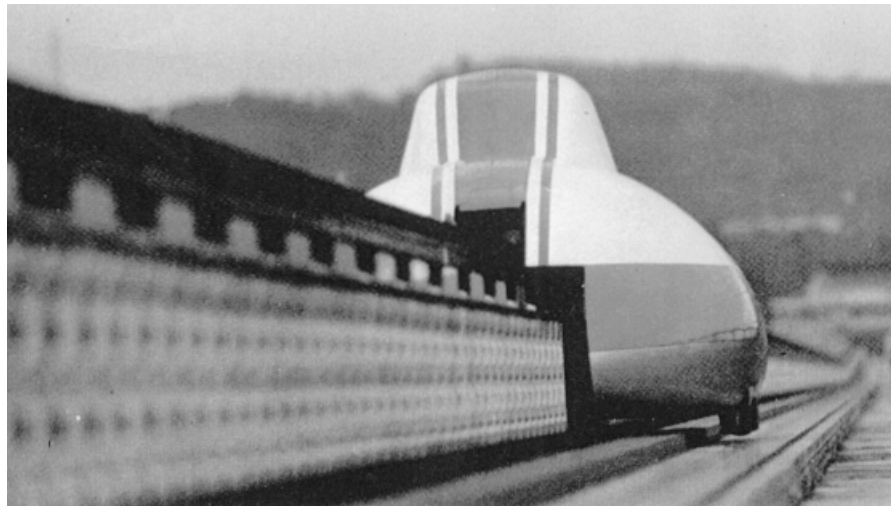

The ML-500 test reached a speed of 517 km/h in 1979

(RTRI)

sides. Thus, the train does not carry equipment such as transformers and inverters. As a result, it is very light and slim, but still capable of harnessing a large propulsive force. Another advantage is that there are no current collectors and electromagnetic force levitates the vehicles, so there are no wheels or rail adhesion problems.

Different types of linear motors have been developed, but the only other type that

supplies electric power to a guideway for transport is Germany's Transrapid system. As mentioned, superconducting magnets are used create a strong magnetic force to propel the vehicle. But they offer more than just propulsion—they also levitate the vehicles and guide them within the bounds of the guideway.

The system takes advantage of the naturally stabilizing effect provided by electromagnet induction. No controlling devices whatsoever are needed to keep the train on its guideway, and there is no risk of the train 'derailing.' The magnetic levitation force is ideal for supporting a train at very high speeds.

Development History

In the early development stages, superconducting magnet technology was considered an esoteric technical field and some people assumed that the technology could never be used for commercial train travel. But the former Japanese National Railways (JNR) was convinced that the technology held great potential for very fast rail travel, and began conducting maglev R&D in 1970.

In 1977, experiments began in earnest on



MLU001 Three-car train on Miyazaki Test Track

(RTRI)

the Miyazaki Test Track in southern Japan. In 1979, the prototype ML-500 test train reached an unmanned speed of 517 km/h on the 7-km track, proving the maglev's tremendous potential for high speed. The track was modified later into a more practical U-shaped guideway.

At this stage, the Japanese government started providing the project with financial assistance. The manned MLU001 was the first train set developed with government subsidies and had three cars.

Soon, the MLU002 and then the MLU002N were being used for a wide range of experiments on the Miyazaki Test Track. But the test track was too short and only had a single guideway with no tunnels and almost no gradients. Obviously, the experimental data from the track would be too limited to verify the maglev's commercial potential.

After JNR was split and privatized in 1987, the Tokaido Shinkansen experienced a dramatic increase in passengers, leading to more calls to build a commercial superconducting maglev as soon as feasible. As a result, the Yamanashi Test Line was constructed in Yamanashi Prefecture, 100 km west of Tokyo.

The Yamanashi Test Line

The 18.4-km Yamanashi Test Line supports a wide range of tests to determine the commercial viability of superconducting maglev transport. It was built by JR Central, which hopes to operate a maglev between Tokyo and Osaka, and RTRI, which took over superconducting maglev development from the former JNR. The Japanese government provides considerable financial assistance.

Tunnels make up 16 km of the line and there is one open section 1.5-km long almost in the middle of the line. A substation for power conversion, and other facilities are located at the test centre on the open section. Part of the line is double-tracked to simulate actual operating conditions. This makes it possible to conduct tests with trains travelling in opposite directions and passing each other at high speed. The maximum gradient is 40 per mill, while conventional shinkansen lines are 30 per mill at most.

A total of 7 cars have been developed for two train sets. The head cars are 28-m

long, and the middle cars are 22 to 24 m. The 20-tonne cars are only half the weight of the latest shinkansen carriages because they use a linear motor system with excellent propulsive power.

Another special feature of the maglev car is the articulated system used to connect cars. We chose this system in order to reduce the height of the carriage body and to facilitate installation of magnetic shielding in passenger compartments. The shield reduces the magnetic field at seats closest to the superconducting magnet to about 4 gauss. For the sake of comparison, hospitals recommend 5 gauss as the maximum permissible exposure for a pacemaker wearer.

Results from Yamanashi Test Line

Trial runs were begun on the Yamanashi Test Line in April 1997. The first train set of three cars was powered by a linear motor but driven at low speed. In early tests, the cars were not levitated; instead, they ran on rubber tyres. Once tests verified that there were no defects in the vehicles or guideway, levitation runs began at the end of May 1997. Thereafter, speed was increased in very small increments over a considerable period of time, with continual monitoring to measure car movement and verify braking performance. On 12 December 1997, a new world record of 531 km/h was set for manned train travel. Then, a maximum speed of 550 km/h was achieved on 24 December for an unmanned run, thereby achieving one of the original objectives of the Yamanashi Test Line.

Only one problem remains to be solved—air vibration that rattles the windows of buildings near tunnel portals when a maglev train enters or leaves a tunnel at high speed. We are presently attempting to solve this problem by installing air baffles at tunnel portals, and by modifying



This five-car train set registered a record speed of 552 km/h on 14 April 1999

(RTRI)

the opening design (*JRTR* 22 pp. 48–57). There are no other environmental problems—ground vibration measurements indicate values well within acceptable limits and noise levels are also within acceptable limits. Aerodynamic noise can probably be reduced further by making the cars even more streamlined. Measurements of the magnetic field, at ground level directly under the standard 8m-high elevated guideway show a magnetic field of only 0.2 gauss caused by Maglev trains imposed on the constant terrestrial magnetism of 0.4 gauss.

A second train set was completed at the end of 1997, making it possible to conduct various tests with two trains, such as one train passing a stationary train or a train moving slowly in the same direction, or two trains travelling in opposite directions at high speed.

In February 1999, to more closely simulate future commercial operations, the 3-car train set was changed to a 5-car configuration for performance tests at speeds in the 500-km/h range. No problems were observed and on 14 April 1999, this manned 5-car train set registered a record speed of 552 km/h.

In May 1999, the cars were rearranged in their original configuration of two 3-car train sets and high-speed tests are continuing to confirm dependability. The trains run up to 44 times a day at around 500 km/h, and results are good.

After reducing aerodynamic vibration in autumn 1999, we conducted high-speed runs on the open section of the guideway. The vibration of trains passing at relative speeds as high as 1003 km/h was so small that it was felt only by someone actually expecting it.

Future Tests

Test runs on the Yamanashi Test Line were planned for a period of 3 years (1997–99). No major problem was experienced

during this time, and we have achieved all of our original objectives, including a maximum speed of 550 km/h and relative passing speeds of 1000 km/h.

The Ministry of Transport established the Maglev Technical Performance Evaluation Committee to verify the technical merits of the system. The Committee report said, 'Although further study is required to evaluate long-term durability and cost effectiveness, it appears that the superconducting maglev system is technically ready to be used commercially as a very high speed, large-capacity transportation system.'

During the next 5 years we will continue to conduct test runs and develop the system further, while focusing on these three objectives:

- Verifying long-term durability
- Finding ways to reduce costs
- Achieving more aerodynamic car design

Conclusion

The superconducting maglev is an entirely new type of railway that combines the latest technologies in power electronics (e.g., superconducting magnets), communications and other high-tech fields. Maglev development sets a new course for rail transport and is a significant milestone in the 170 years of railway history. Air resistance is the only factor limiting the speed of this system, so there is every reason to believe that speeds will be raised dramatically by, for example, using maglev technology in a vacuum. This innovative made-in-Japan technology is about to revolutionize train travel for several centuries to come. ■

2. Normal-conducting HSST Maglev

Munenobu Murai and Masao Tanaka

Japan and Germany are developing different types of normal-conductive magnetically levitated linear motor trains. Japan is developing the High Speed Surface Transport (HSST) system, while Germany is developing the Transrapid system.

The two systems are similar in the sense that they both use linear motors for propulsion, and electromagnets for levitation. However, the type of linear motor used is different.

The HSST is propelled by linear induction motors. The HSST primary coils are

attached to the carriage body and the track configuration is simple, using steel rails and aluminium reaction plates. On the other hand, Transrapid trains are propelled by a linear synchronous motor. The motor primary coils are mounted on the guideway, and the levitation magnets are attached to the car and act as field magnets. These differences can be explained by the fact that in the early development, the Japanese and German systems were not meant to operate at the same speed. Early plans called for the HSST to run at a maximum speed of 300 km/h, although

development efforts are now focusing on intra-urban trains running at about 100 km/h. For their part, Transrapid developers are aiming for cruising speeds of 450 to 500 km/h.

Since the recent decision to use the HSST system on the Tobu Kyuryo Line in Aichi Prefecture, central Japan, this new technology is now closer to practical application. Once constructed, the track will become the world's first commercial line. This article briefly explains Japan's HSST system.

The HSST System

HSST research began in earnest in 1974 when Japan Airlines (JAL) began promoting a new linear motor car system. At the time, high-speed access between Tokyo and New Tokyo International Airport (Narita) was considered a matter of priority, because the airport was being constructed about 60 km from Tokyo's core. To reduce access time, JAL proposed a maglev train propelled by linear motors at a target speed of 300 km/h.

Magnetic levitation

The HSST levitation system uses ordinary electromagnets that exert an attractive force and levitate the vehicle. The electromagnets are attached to the car, but are positioned facing the underside of the guideway's steel rails. They provide an attractive force from below, levitating the car (Fig. 1).

This attractive force is controlled by a gap sensor that measures the distance between the rails and electromagnets. A control circuit continually regulates the current to the electromagnets, ensuring that the gap remains at a fixed distance of about 8 mm. If the gap widens beyond 8 mm, the current to the electromagnets is increased to create more attraction. Conversely, if the gap becomes less than 8 mm, the current is decreased. This action is computer controlled at 4000 times per second to ensure stable levitation.

As shown in Fig. 1, the levitation magnets and rail are both U-shaped (with the rail being an inverted U). The mouths of each U face one another. This configuration ensures that whenever a levitational force is exerted, a lateral guidance force occurs as well. If the electromagnet starts to shift laterally from the centre of the rail, the lateral guidance force is exerted in proportion to the extent of the shift, bringing the electromagnet back into alignment.

The use of an electromagnetic attractive force to both levitate and guide the car is a significant feature of the HSST system.

Propulsion

We can visualize an HSST linear motor as an ordinary electric induction motor that has been split open and flattened. This type of linear motor has recently been used in various fields.

As Fig. 2 shows, in the HSST, the primary side coils of the motor are attached to the car body, and the secondary side reaction plates are installed along the guideway. These components act as an induction motor, and ensure both propulsion and braking force without any contact between the car and the guideway.

The system is called a car-mounted primary linear induction motor system. The ground side requires only a steel plate backed by an aluminium or copper plate, meaning that the rail structure is simple.

Module structure

One of the HSST's unique technical features is its modules that correspond to the bogies on conventional rolling stock. As Fig. 3 shows, each module consists primarily of a number of electromagnets for levitation and guidance, a linear motor

Figure 1 Principle of HSST Magnetic Levitation

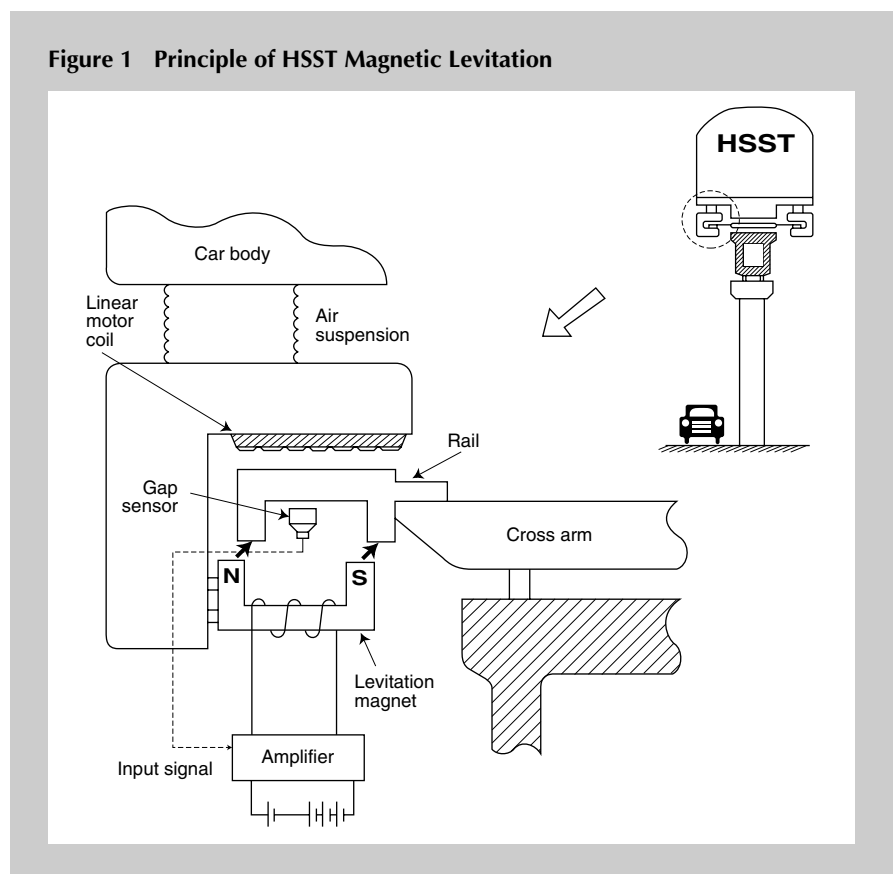

for propulsion and braking, and a hydraulic brake system.

The two modules on the left and right sides of the car are connected by beams, and this unit is called a levitation bogie. Because the levitation bogies run the entire length of the car, the load of the car and the load on the guideway are spread out and the advantages of magnetic levitation can be fully exploited.

Advantages offered by HSST system

HSST cars do not need wheels and this offers a number of advantages that are summarized below.

- Safe
The vehicle is designed so that it 'interlocks' with the guideway, so there is no risk of derailment. The electromagnetic field level inside the vehicle is no more than that in conventional electric trains.
- Reduced noise and vibration
When the vehicle is running there is no physical contact between the carriages and the guideway which minimizes rolling noise and vibration.
- Accelerates and decelerates quickly
Acceleration and deceleration can be rapid and fairly steep grades can be climbed easily.
- Low maintenance
There are fewer moving and rolling parts so wear and tear is less, ensuring easy maintenance of vehicles and guideways.
- Economical
The HSST can operate on fairly steep gradients and tight curves, and there is no axle load on small spans of track, so guideway construction costs are quite low.

Figure 2 Principle of HSST Magnetic Propulsion

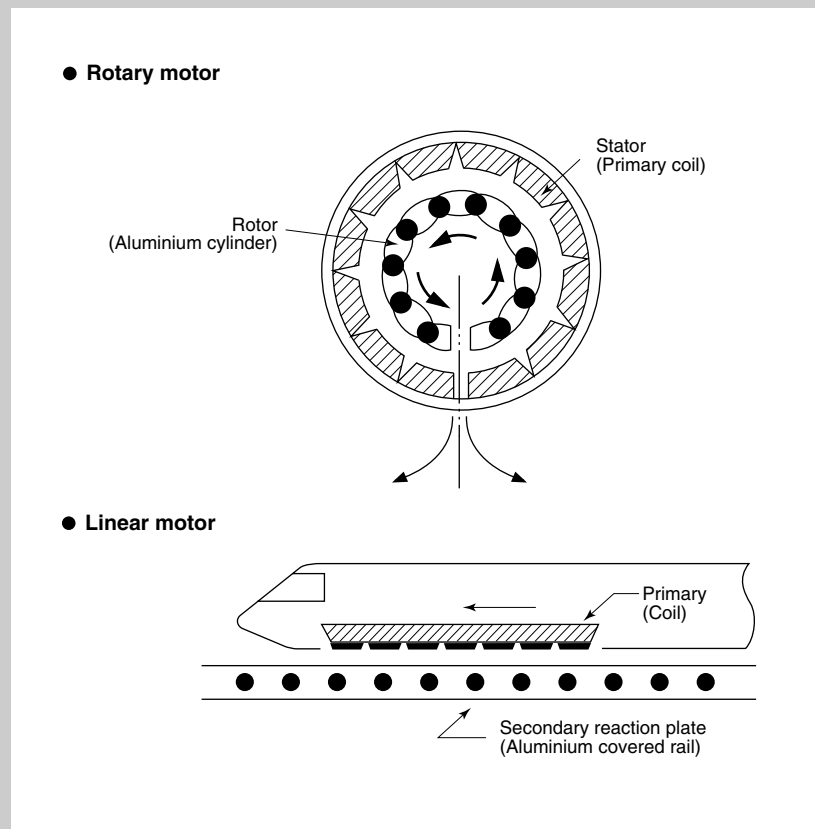
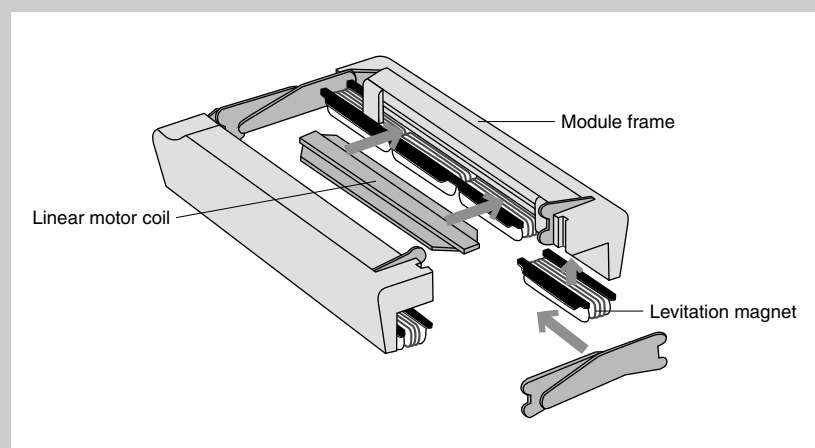

Figure 3 HSST Module Construction



History of HSST Development

When HSST development began in 1974, research focused on the basic technology required for levitation, propulsion and braking. In the early days, the target speed was 300 km/h. A 1.6-km test track was constructed on Higashiogishima in Kawasaki where the HSST-01 unmanned experimental vehicle reached a speed of 308 km/h. In demonstration runs, the 8-seat HSST-02 achieved a maximum speed of 100 km/h. Some 7 years after these development efforts, the basic technology was recognized as sound.

The HSST-03 (1984) was the first to model to use modules and could carry 50 passengers. It showed great promise and carried more than 1 million passengers when demonstrated at The International Exposition, Tsukuba in Japan in 1985, and at EXPO '86 Vancouver in Canada.

The HSST-04 was completed in 1988 and ran at the Saitama Expo in Kumagaya, Saitama Prefecture. The vehicle ran on an elevated guideway and the Variable Voltage Variable frequency (VVVF) inverter was mounted on the car, instead of on the ground as in previous models. By this time, it appeared that the HSST

system was ready for commercial use.

The HSST-05 composed of two HSST-04 cars ran at low speeds at the Yokohama Expo in 1989, although its basic design concept envisioned a speed of 200 km/h.

HSST-100 Test Track

The basic design of the system up to and including the HSST-05 aimed for speeds of about 200 km/h. But the focus changed in 1989 when a project was launched to develop the HSST for urban transport.

Until then, researchers had only determined what basic technical specifications were required for an HSST-100 vehicle. Under the new project, a test track and vehicles were constructed and test runs were conducted. The objective was to determine the practicality of such a system for mass transit. The evaluation examined various factors, including safety, reliability and cost.

The private Nagoya Railroad Co. Group in Aichi Prefecture spearheaded the project. After the Chubu HSST Development Corporation was established in 1989, it was given the task of testing and developing the HSST-100 series. At the same time, the Aichi

prefectural government established a committee that later issued a report entitled *A Feasibility Study of Urban Mass Transit by Linear Motor-Driven Maglev*. The committee, chaired by Professor Eisuke Masada, was composed of technical experts, as well as representatives from the Ministry of Transport, the Ministry of Construction, manufacturers and other organizations. It set out guidelines recommending how the test track should be constructed and how trial runs should be conducted, and carefully scrutinized test results. A wide variety of trials were successfully completed, and in 1993 the committee reported that the HSST was sufficiently developed to be used for public mass transit.

The test track constructed by Chubu HSST Development Corporation is 1.5-km long and extends from Oe Station on the Chikko Line of Meitetsu in the southern part of Nagoya City (Fig. 4). The track is elevated, except for about 400-m at ground level. To test operations under such extreme conditions, it includes a steep grade (70 per mill) and sharp curves. The test vehicles are the two-car 100S and 100L built in 1991 and 1995, respectively. Each 100S car has three levitation bogies (6 modules). Car size is about the same as the new Automated Guideway Transit (AGT) cars such as *Yurikamome* (JRTR 16, pp. 15–19) that run on rubber tyres. Each 100L car has five levitation bogies. Although the 100L is larger than the 100S, the basic configuration is exactly the same. One reason for developing the 100L was to achieve more efficiency with greater carrying capacity. Table 1 shows the basic specifications of the 100L and its test track.



HSST-01 experimental vehicle in 1975

(Chubu HSST Development Corp.)

Tobu Kyuryo Line Project

The Tobu Kyuryo Line will extend about 9.2 km from Fujigaoka subway station in Meito Ward, Nagoya (Aichi Prefecture) through Nagakute Town to Yakusa Station on the Aichi Kanjo (Loop) Line in Yakusa-cho of Toyota City.

In 1992, the government Council for Transport Policy recommended that the Tobu Kyuryo Line be constructed as a medium-weight track, and that the transit system for this line be completed by 2008. A committee was asked to recommend what type of train should be used and it recommended a maglev system; this proposal was accepted in 1999. In February 2000, Aichi High Speed Transport Inc. was established, and given primary responsibility for operating the line. The stage has been set for construction and plans call for the line to open in time for the EXPO 2005 Aichi. The line will extend from Fujigaoka



HSST-100L vehicle on elevated test track in Nagoya City

(Chubu HSST Development Corp.)

Figure 4 HSST-100 Test Track

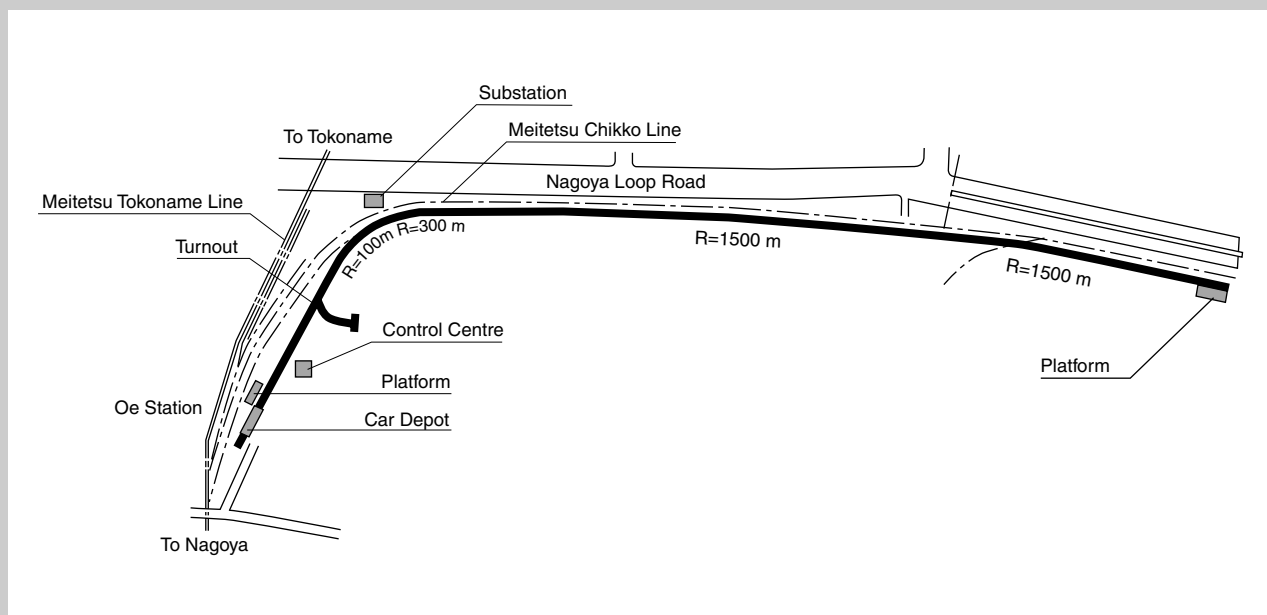

Table 1 HSST-100L Test Vehicle and Chubu HSST Development Corp. Test Track

Vehicle performance	Maximum speed	100 km/h
	Maximum acceleration	4.5 km/h/s (with variable load control)
	Maximum deceleration	4.5 km/h/s (with variable load control)
	Maximum deceleration (emergency)	4.5 km/h/s
	Minimum curve radius	50 m
Car body	Train set	2 cars per set
	Passenger capacity (head per car)	68 (33 seated) per car 110 per car during peak (0.14 m ² per passenger)
	Car dimensions	Length 14.4 m; width 2.6 m; height 3.2 m
	Weight of set	About 32 tonnes empty (2 cars); 50 tonnes full (2 cars)
	Levitation and guidance system	Maglev system uses attractive force of U-shaped electromagnets for levitation and guidance
	Levitation gap	Magnetic gap of 8 mm
	Electric motors for propulsion	10 Linear induction motors per car
	Control unit	VVVF Inverter 1560 kVA; 800 A maximum Frequency 0-90 Hz; 1 unit per car
	Bogie system	Modules: 10 modules per car (5 each side) Module pitch: 2500 mm per unit
	Electrical system	1500 Vdc
	Service braking system	Electric brake; hydraulic brake
	Emergency braking system	Hydraulic brake
	Auxiliary power unit	DC/DC Converter (112 kW continuous rating)
	Air temperature control	Heat pump system for cooling and heating
Operator	One driver	
Test track	Total length	1.5 km
	Standard beam structure	Single beams: prestressed concrete beams, steel sleepers
	Minimum curve radius	Main line, 100 m; turnout, 80 m (equivalent)
	Maximum grade	70%
	Switching mechanism	Simple three-segment horizontally rotating switch
	Current collector	Al/SUS Compound rigid trolley rail
	Regenerative power absorber	Resistor absorbing with GTO Chopper
	Braking system	ATS Device

Station to Yakusa Station (both station names are still provisional) and trains will take about 15 minutes to travel the 9.2 km at a maximum speed of 100 km/h (Fig. 6). Daily passenger density is forecast to be about 30,000.

According to the plans, a double guideway will serve nine stations (including the two termini) with an underground section of 1.4 km and a surface section of 7.8 km. The line will be regulated by normal railway regulations and twenty 100L trains will run during each peak hour.

More information on the Tobu Kyuryo Line project can be obtained by visiting the Aichi Prefecture website at: <http://www.pref.aichi.jp/index-e.html>

Conclusion

Twenty-five years have passed since the HSST-01 made its first levitated run in 1975. The passing years have been characterized by repercussions of the two oil crises, Japan's bubble economy in the

Figure 5 HSST-100L Vehicle Design

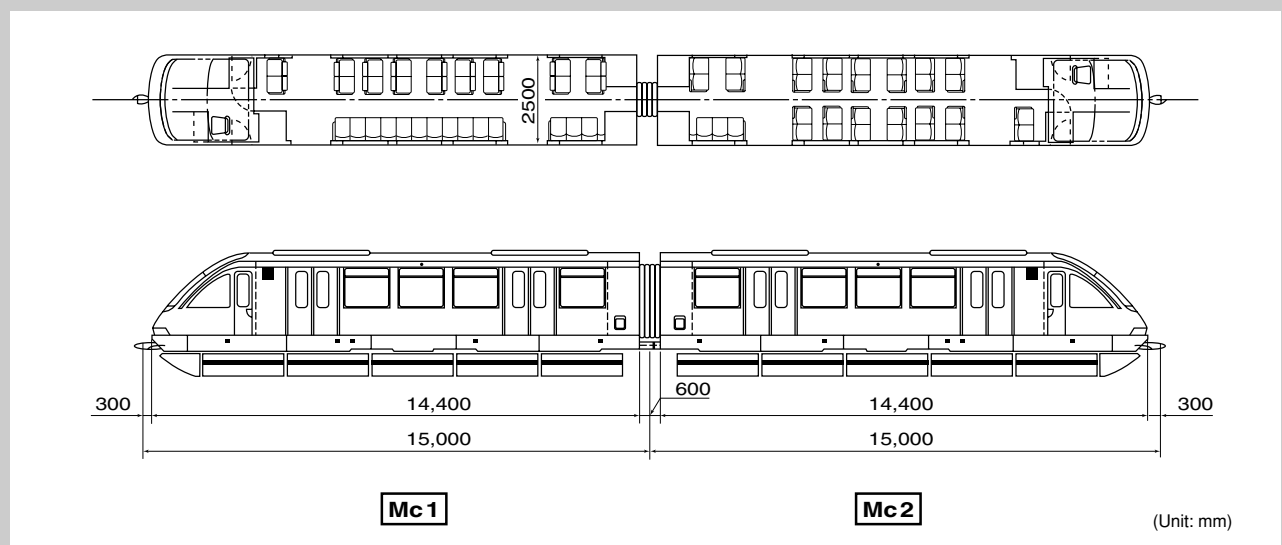
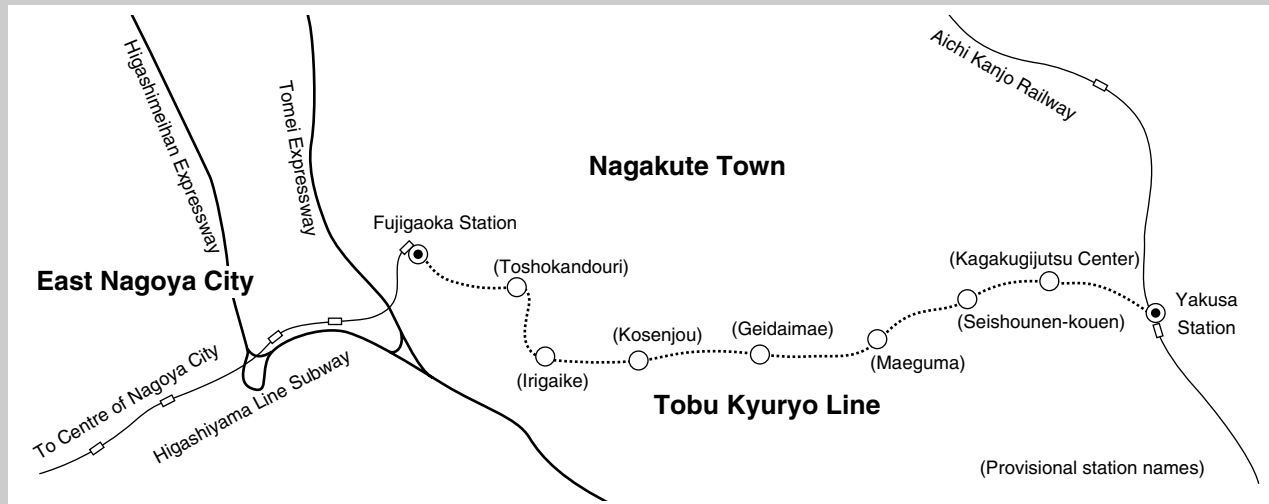

Figure 6 Route of Tobu Kyuryo Line



late 1980s, and recession in the 1990s, but HSST R&D has continued successfully. With the recent decision to use HSST technology on the Tobu Kyuryo Line in Aichi Prefecture, the first commercial HSST line will soon be a reality. We must thank the many people whose years of effort will soon bear fruit. ■

Further Reading

Jiki fujotetsudo no gijutsu (Maglev Railway Technology), Masada, Fujie, Kato, Mizuma, Ohmsha, September 1992.

Kanji Wako

Mr Kanji Wako is Director in charge of Research and Development at the Railway Technical Research Institute (RTRI). He joined JNR in 1961 after graduating in engineering from Tohoku University. He is the supervising editor for this series on Railway Technology Today.



Kazuo Sawada

Mr Sawada is General Manager of Technology in the Maglev System Development Department of RTRI. He graduated in electronic engineering from the University of Tokyo in 1971 and then joined JNR. He has worked on the maglev project since 1974, holding various senior posts at the Miyazaki Test Track and RTRI.



Munenobu Murai

Mr Murai is Manager of Electrical Systems at Chubu HSST Development Corporation. He graduated in electronic engineering from Hokkaido University in 1972 and then joined Japan Air Lines where he was responsible for development of rolling stock and electrical systems. He transferred to HSST Development Corporation in 1986.



Masao Tanaka

Mr Tanaka is Manager in charge of rolling stock at Chubu HSST Development Corporation. He graduated in electrical engineering from Nagoya University in 1978 and then joined Nagoya Railroad Co., Ltd. (Meitetsu) where he worked until 1990.